



Es'hail 2 / QO-100

Erwin Rauh DL1FY, September 2019

Agenda

1. Control Unit
2. Duo-Feed LNB
3. Configuration

Es'hail 2 / QO-100 Project Control Unit



↑ Power ON/OFF
↑ Control LED
↑ LNB-Power ON/OFF
↑ Main Fuse



↑ 13cm PA Power Control
↑ Power 12 VDC
↑ Out 13cm
↑ USB PC
↑ GPS LNB
↑ RX-435MHz LNB CLK
↑ IF 28, 144, 433, 1296 MHz



Es'hail 2 / QO-100 Project

Control Unit schematic construction

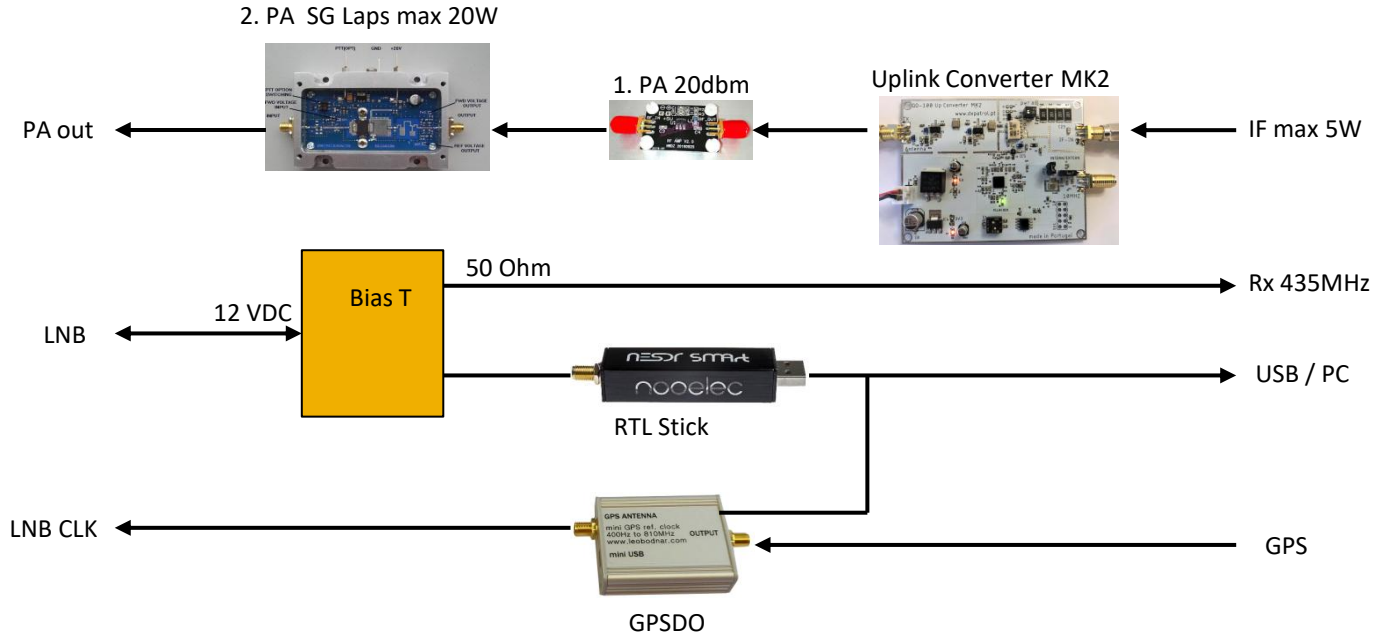

Es'hail 2 / QO-100 Project

Duo-Feed LNB



LHCP Helix Antenna

Modified Octagon
LNB for external CLK

Es'hail 2 / QO-100 Project

Equipment used at DL1FY



SDR Console, Control Unit, FT-847

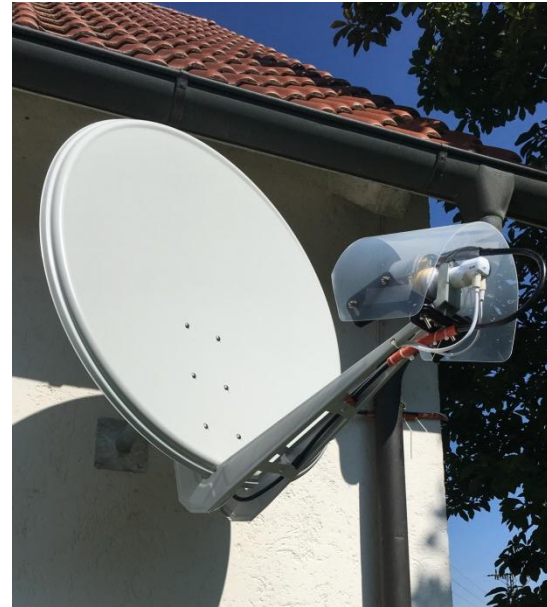

Dish d= 1m, Duo-Feed (Helix ANT + LNB)

Es'hail 2 / QO-100 Project Configuration

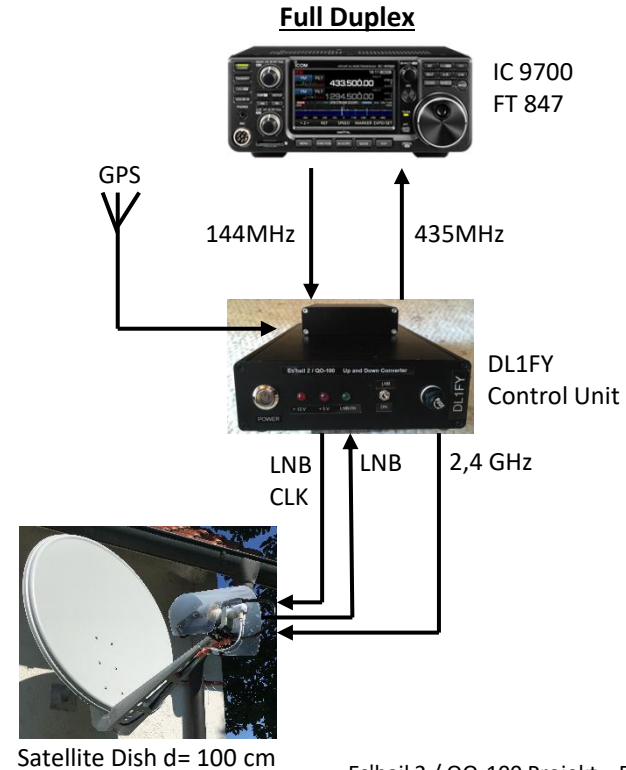

Es'hail 2 / QO-100 Project Configuration

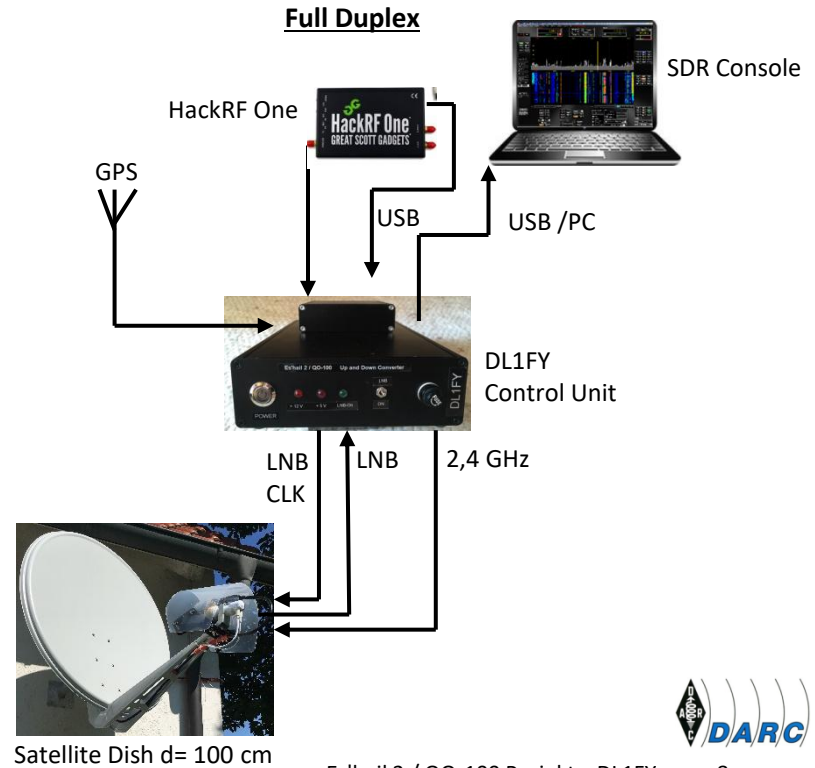
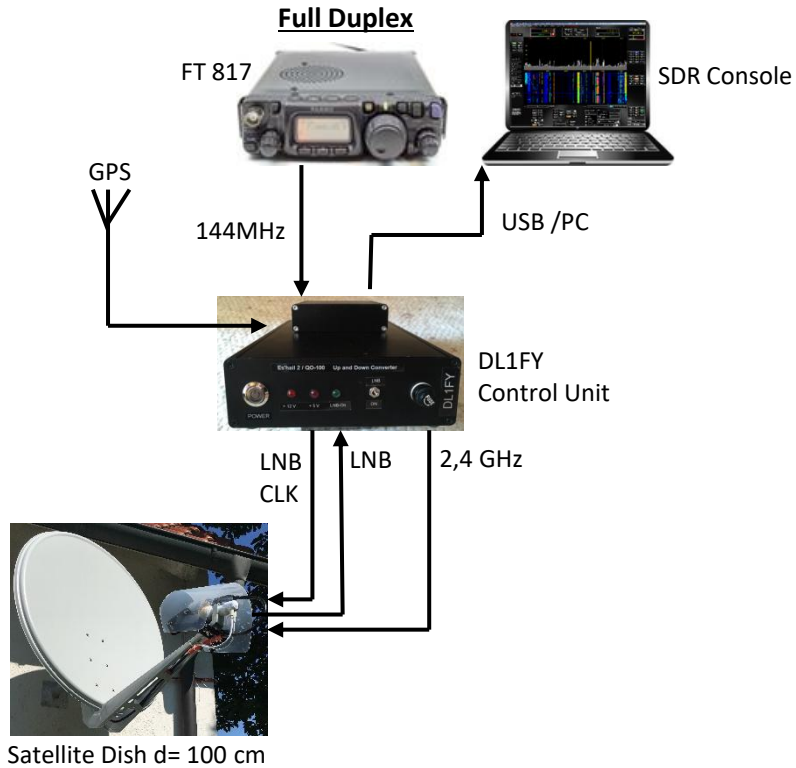

Es'hail 2 / QO-100 Project Configuration

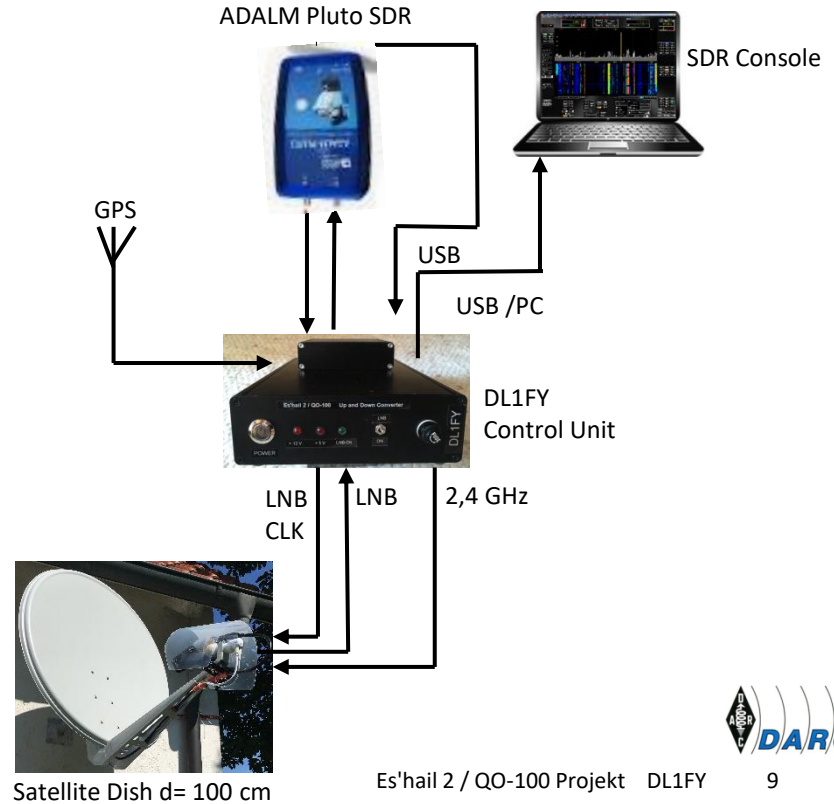
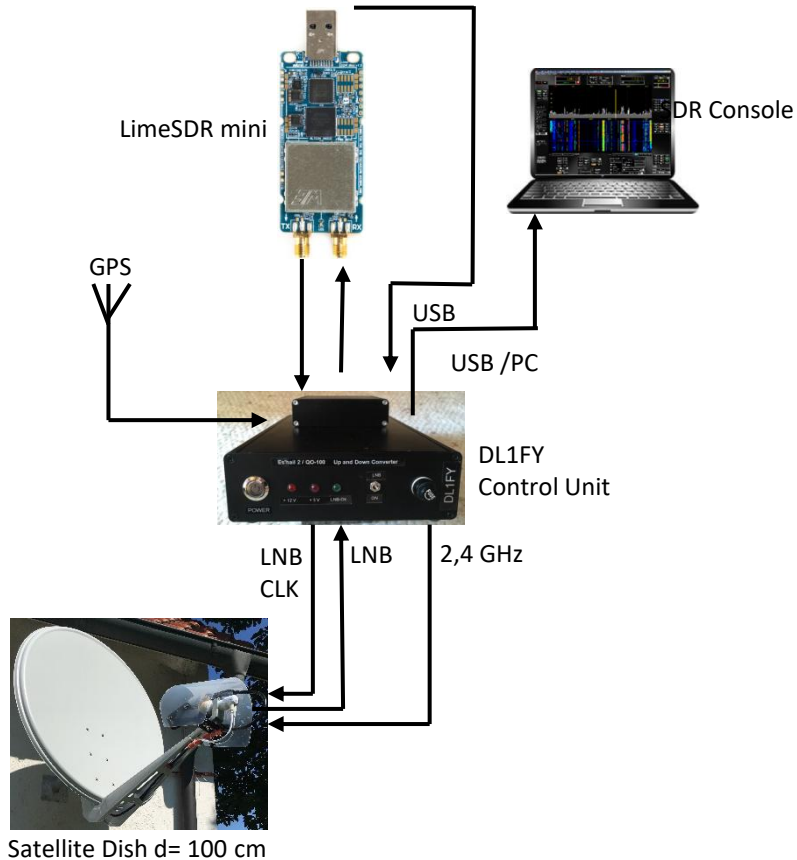

THANK YOU!

